



Quick
Veneer™

QUICK...
SIMPLE...
STRONG...

**A Better Way
to Veneer!**

**Built by a Metal Building Contractor,
For Metal Buildings Contractors.**

Quick Veneer™



Each Quick Veneer order comes with the panels and:

- Blue bottom clips
- Red top clips
- White mid-clips
 - 7.2 panels only
- Bolts and washers for clip to panel attachment
- Material handling information
- Erection guide information
- Project erection drawings

Quick Veneer works with Metal Buildings

- We allow for ½" caulk joint between panels
- Quick Veneer works on projects with standard panels and insulated metal panels
- Full Cavity insulation is installed easily with Quick Veneer
- Custom window/opening cut outs are provided as needed
- Trim packages are designed and supplied by your metal building provider



Advantages of Quick Veneer for the Metal Building Contractor

- Significant cost savings versus traditional masonry veneer
- Strength and longevity of pre-cast concrete
- Designed with the builder in mind
 - Simple rigging
 - Easy to erect
 - No heat needed for winter installation
- Erector controls the entire process of enclosing the building envelope
- Protects the metal wall panels at the base
- Looks great and adds value to the Metal Building

4.0 PANEL

QV3D-4.0

Scale: N.T.S.

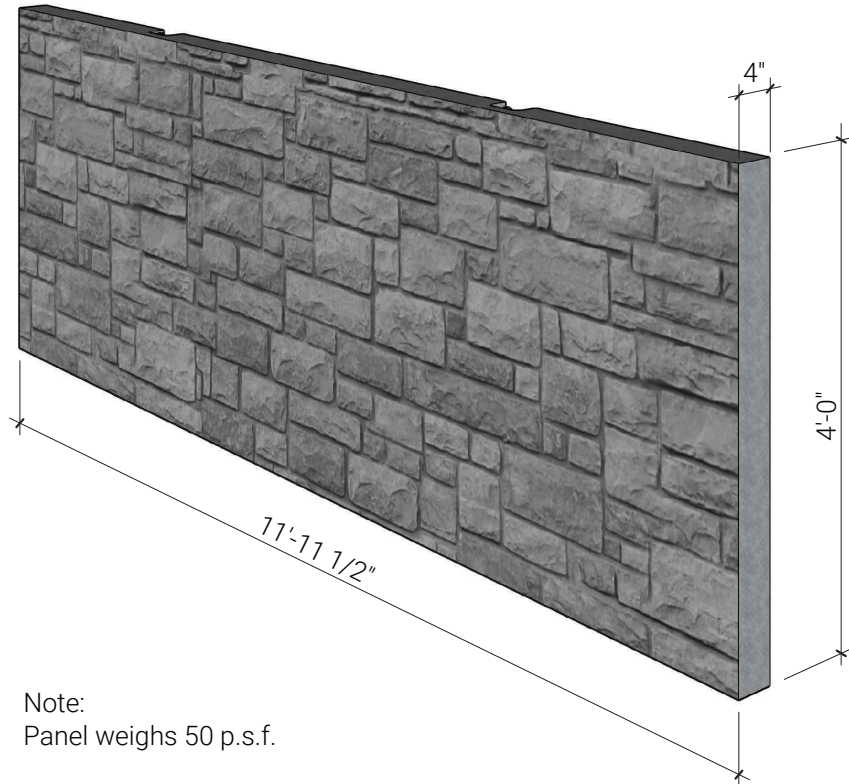
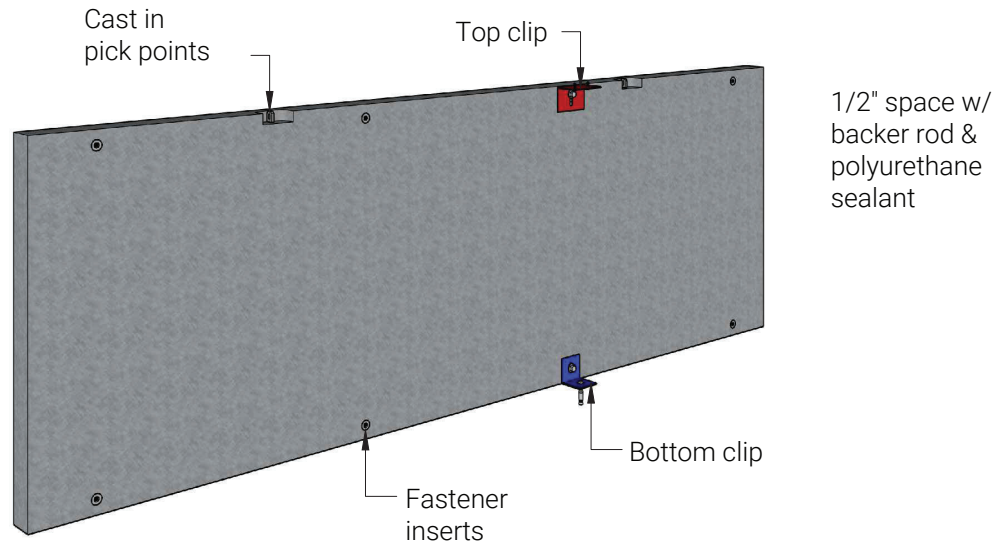

7.2 PANEL

QV3D-7.2

Scale: N.T.S.

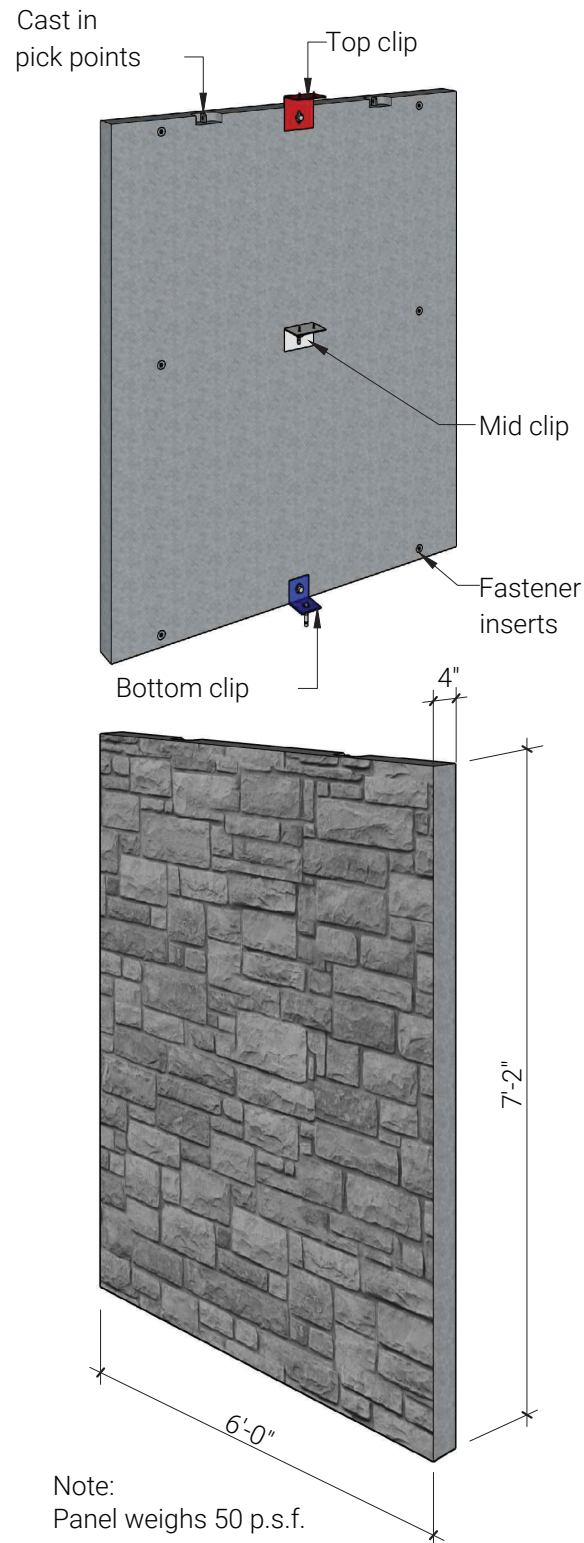

4.0 PANEL PEMB FULL CAVITY INSULATION

QVD-201

Scale: 1/2" = 1'-0"

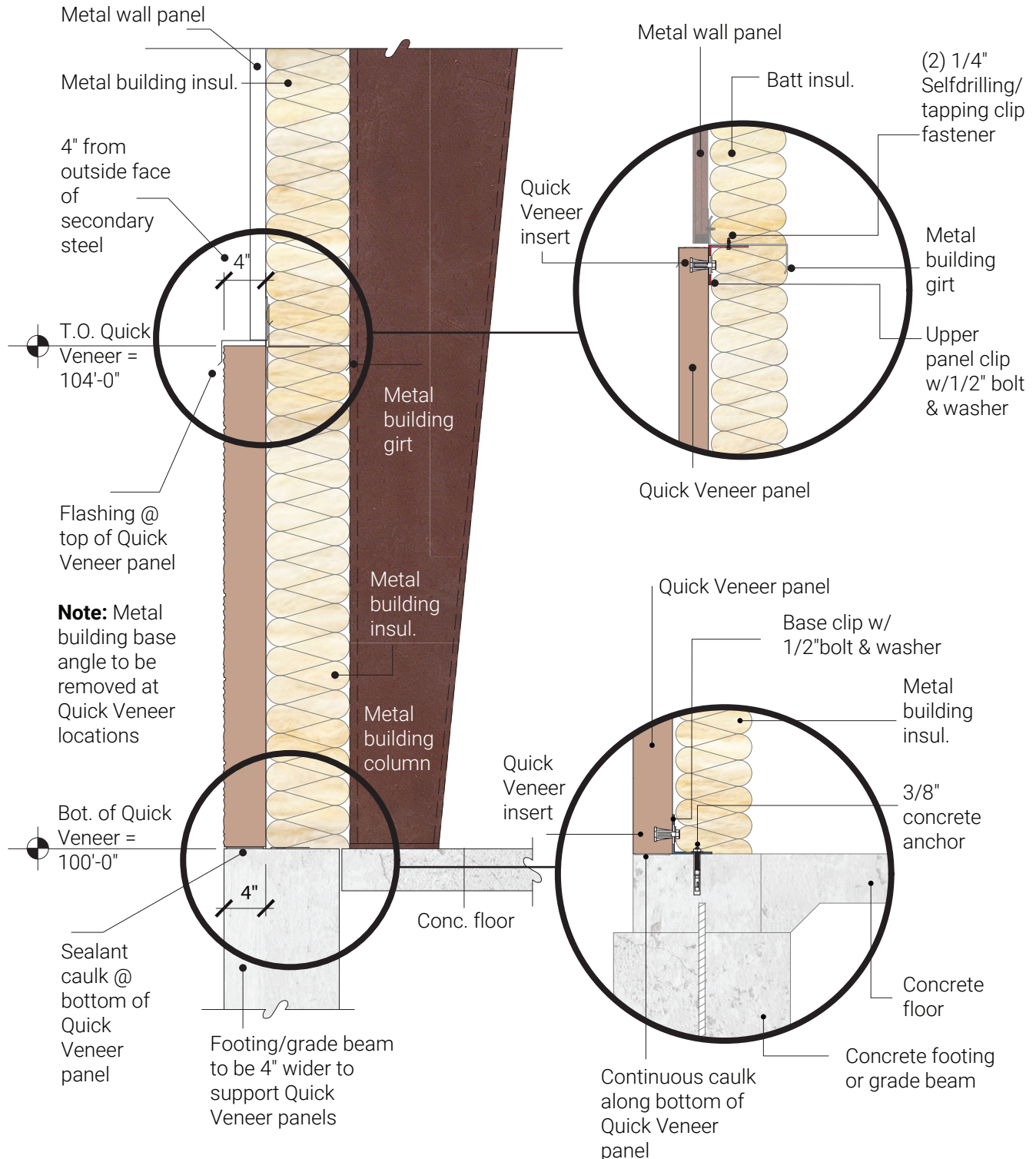

4.0 PANEL FOUNDATION NOTCH

QVD-204

Scale: 1/2" = 1'-0"

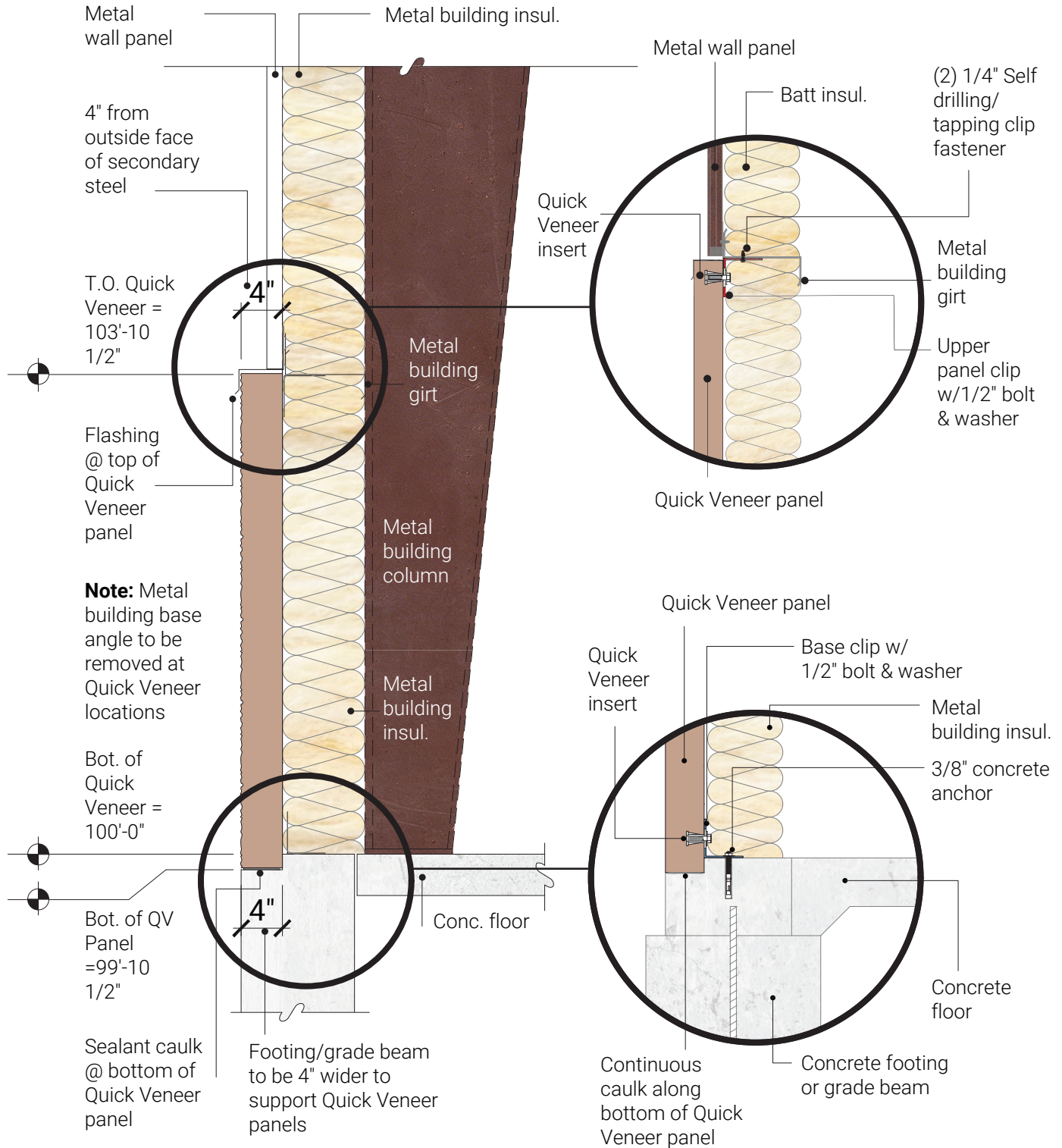

7.2 PANEL PEMB FULL CAVITY INSULATION

QVD-205

Scale: 1/2" = 1'-0"

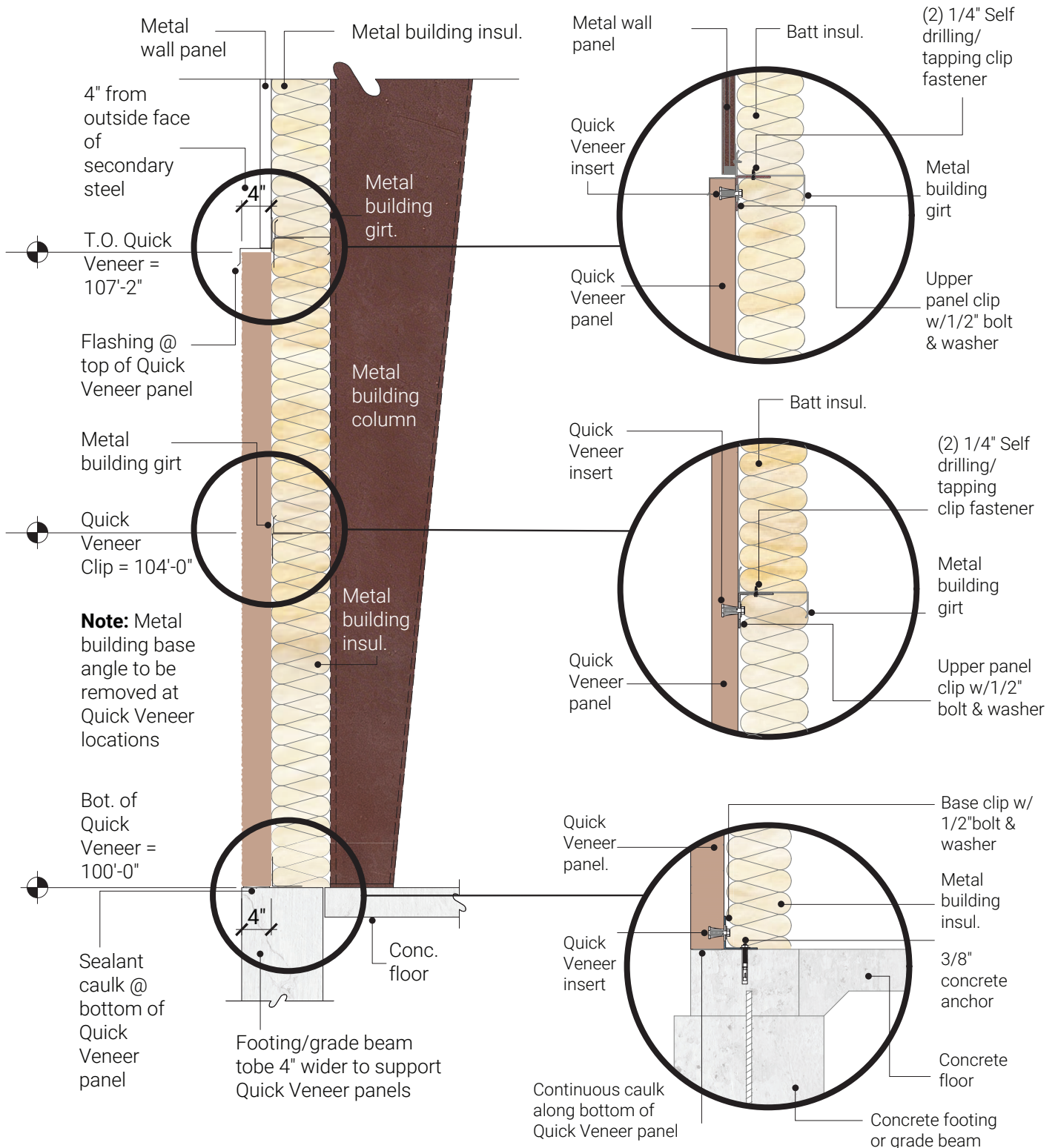

OUTSIDE CORNER DETAIL

QVD-001

Scale: 1/2" = 1'-0"

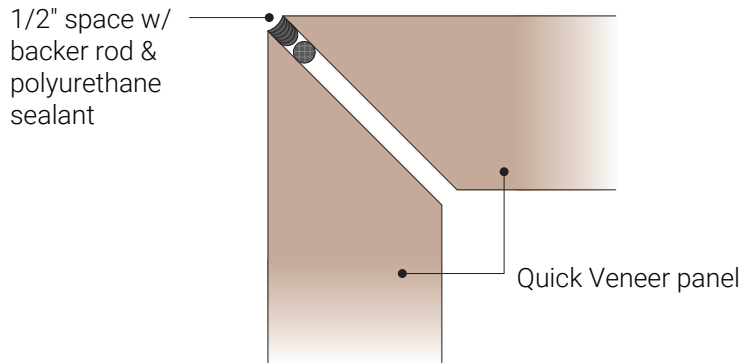

INSIDE CORNER DETAIL

QVD-002

Scale: 1/2" = 1'-0"

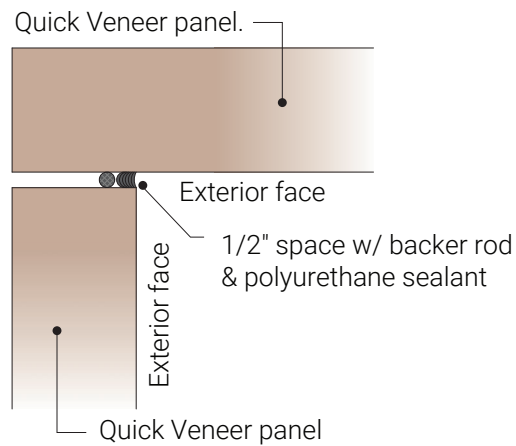

PANEL JOINT DETAIL

QVD-003

Scale: 1/2" = 1'-0"

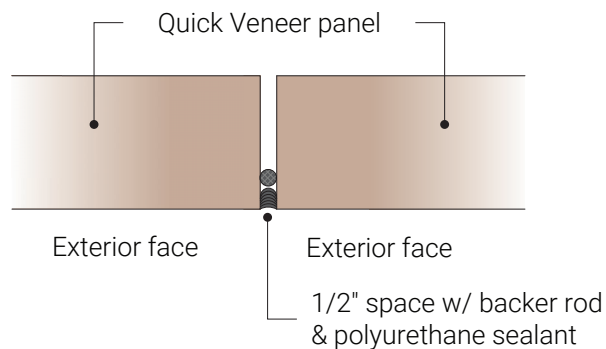

E5® INTERNAL CURE

- Proprietary Nano Silica particles in suspension
- ASTM C 494 Type S admixture
- Precisely sized nanoparticles for optimal water control
- Self-curing, eliminating all other, less efficient curing methods
- Increased hydration for densified concrete matrix
- Harder, denser concrete surface

E5® LIQUID FLY ASH

- Proprietary blend of Nano Silica particles in suspension
- Liquid SCM @ 8 oz/cwt
- Most efficient SCM for consuming calcium hydroxide
- Wider particle band
- Molecular particle packing for dense concrete
- Carbon reduction, replacing up to 10% of cement

Quick Veneer utilizes a combination of products from E5 to create our waterproof panels. E5 internal cure and E5 LiquidFly Ash, Incorporated into our high strength concrete reduces permeability and creates a self-healing quality for our panels. Please visit www.E5NanoSilica.com for more information.

MICROSCOPIC OBSERVATION – 0.3% E5® INTERNAL CURE® – SHCC

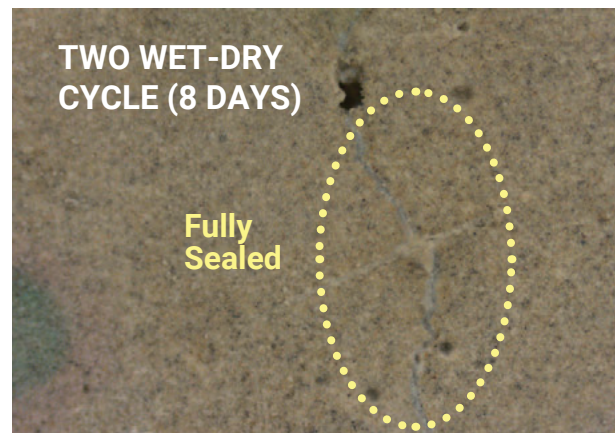
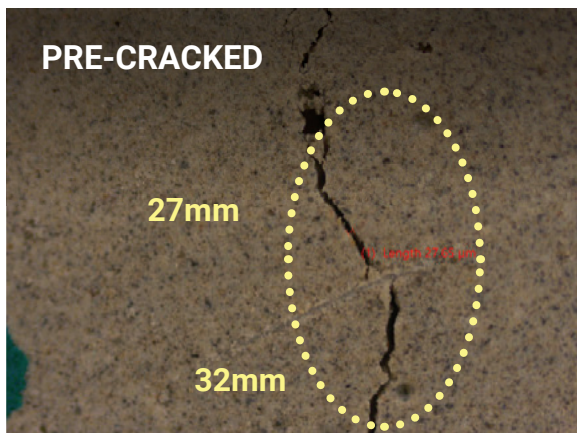

COLOR CHART



Bark

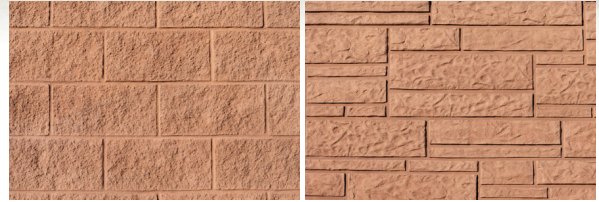

Bark Heavy



Brown

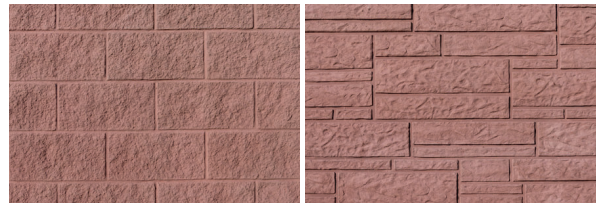

Brown Heavy



Oxide



Oxide Heavy



Saddle



Saddle Heavy



Tan



Tan Heavy



Natural

FACING CHART

STONE

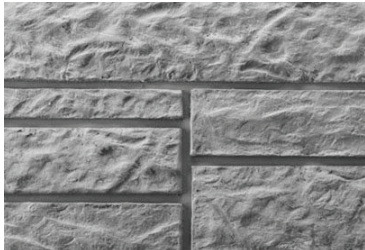

Random Ashlar

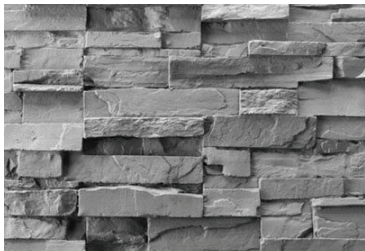

Ledgestone Drystack



Ohio Drystack



Dry Fit Ashlar

BLOCK

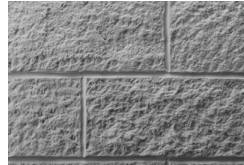

Split Face Concave

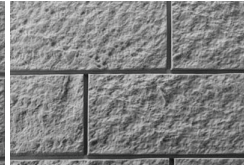

Split Face Raked



Half Split Running Bond

FLAT

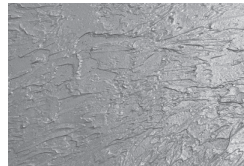

Venetian Stucco



Medium Sand



Bush Hammer

CONTEMPORARY

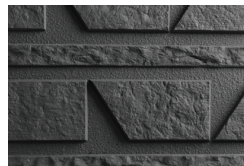

Clickquot

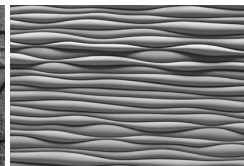

Longmeadow

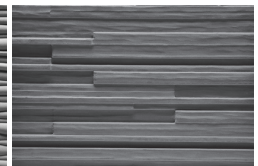

Duxeberry

WOODS



Cedar Stakes



Barn Board

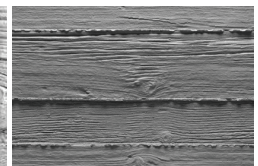

Old Timber

CAST BRICK



18th Century



Modular

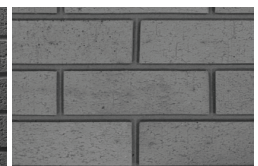

Utility

THIN BRICK

SINGLE TONE & RANGE COLOR OPTIONS



105 Fieldstone



505 Monument



507 Empire



310 Main Street



320 Schoolhouse Red

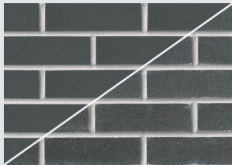

710 Charcoal



29F Copper Ironspot



350 Main Street Flashed



365 Schoolhouse Red



458 Brownstone Flashed

BLENDED COLOR OPTIONS



Fast Ship Blend 1



Fast Ship Blend 2



Fast Ship Blend 3



Fast Ship Blend 4



Fast Ship Blend 5



Fast Ship Blend 6



Fast Ship Blend 7

Thin Brick options shown are a less lead time product. We can provide thin brick from many suppliers including:



Product images are for illustrative purposes only and are intended to represent the general appearance of thin brick and thin brick blending. Variations can and should be expected and are not guaranteed to be an exact match. Please contact Quick Veneer for more information.
© 2026 Quick Veneer. All rights reserved.

Quick Veneer™

The weight of the 4-inch thick normal weight precast concrete wall panels are 50 pounds per square foot based upon 150 pcf normal weight concrete. In most instances, the panels will be supported on the building's foundation system.

The Quick Veneer panels will impose the same tributary loads to girts as metal wall panels.



Vance Behrens, SE
structural[design]group
CA-1478

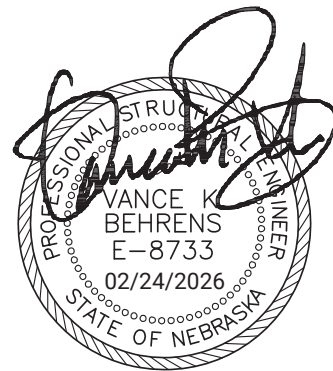

Quick Veneer 5-year limited warranty

Hello and thank you for your interest and purchase of Quick Veneer!

With your purchase of Quick Veneer by Wahoo Concrete Products, Inc. ("Wahoo Concrete Products") we have included this 5-year limited warranty. For a period of 5-years from the date of delivery Wahoo Concrete Products will warrant the Quick Veneer panel for any manufacturing defects. This limited warranty will cover repair or replacement of Quick Veneer or a refund of the purchase price, which is at the discretion of Wahoo Concrete Products. At the time of delivery please be sure to inspect your Quick Veneer and note any defects you encounter. Please note that any panel deemed to be defective should not be installed. Any Quick Veneer considered to be defective should not be installed. This limited warranty does not cover damages by others during the handling and installation of Quick Veneer.

What is covered by this limited warranty

Our system is a pre-cast concrete product. Our high strength concrete panels include steel re-enforcing, fiber re-enforcement and a waterproofing admixture that protects the panel from water infiltration. Some cracking is acceptable during our process and will not pose a structural issue. This limited warranty warrants that the structural integrity of the Quick Veneer panel shall be free from material manufacturing defects.

Labor charges or other costs incurred with removal or installation of either the original or replacement Quick Veneer are not covered by this limited warranty. In the event of replacement under the terms of this limited warranty, the original limited warranty shall apply to the replacement Quick Veneer and will extend for the balance of the limited warranty period remaining at the time of replacement.

Who is covered by this limited warranty

This limited warranty is offer is extended to the original end-user and is non-transferable. "Original end-user" means the original purchaser who contracts through a contractor for the original purchase and installation of Quick Veneer for his or her property, or the first buyer of a property that contains Quick Veneer as a new installation.

To make a claim

To report and initiate a claim call Wahoo Concrete Products at **402-443-4626** or email Wahoo Concrete Products at **office@wahooconcrete.com**. We will ask for a written notice that includes: the issue, including photographed documentation and date of purchase/delivery. Wahoo Concrete Products may then promptly inspect the claimed defective Quick Veneer. All claims made under this limited warranty must be made within sixty (60) days of the date the claimed defect was first discovered or reasonably could have been discovered.

What is not covered by this limited warranty

This limited warranty is for the structural integrity of the system. This limited warranty does not cover the following:

- Color variations that may occur
- Damage during product handling and installation
- Improper installation or construction practices
- Improper use or abuse. "Improper use or abuse" includes, but is not limited to, damage from mishandling of the product, damage from excessive heat or uneven exposure to weather conditions, physical or chemical abuse and damage from improper care and maintenance
- Non-Structural cracking including but not limited to hairline cracks, scratches, chips, or other damage
- Damage caused by drilling into or attempting to alter the product from the way in which it was received
- Water infiltration at the base, the joints or the top of the panels
- UV related fading of the panel color
- Any defects that were visible at the time of installation and were not avoided during installation. Installers are required to perform a visual inspection of all materials prior to installation
- Product that has been moved from its original installation location
- Additional modifications such as plumbing, electrical, tile, cabinets, flooring, etc. that may be necessary to repair or replace the Quick Veneer product covered under this limited warranty
- Any failures due to inadequate support for the installation

WAHOO CONCRETE PRODUCTS' LIABILITY SHALL BE LIMITED SOLELY TO ITS RESPONSIBILITIES UNDER THIS LIMITED WARRANTY. EXCEPT FOR THIS EXPRESS WARRANTY DESCRIBED ABOVE, TO THE EXTENT PERMITTED BY APPLICABLE LAW, THERE ARE NO EXPRESS OR IMPLIED WARRANTIES OF ANY KIND AND THERE ARE NOR WARRANTIES OF MERCHANTABILITY OR FITNESS FOR A PARTICULAR PURPOSE WITH RESPECT TO THE PRODUCT AND NO WARRANTY SHALL BE IMPLIED BY OPERATION OF LAW OR OTHERWISE. IN NO WAY SHALL WAHOO CONCRETE PRODUCTS BE LIABLE FOR INDIRECT, SPECIAL, CONSEQUENTIAL OR INCIDENTAL DAMAGES OF ANY KIND, INCLUDING DAMAGE TO THE BUILDING, ITS CONTENTS OR ANY PERSON. SOME STATES DO NOT ALLOW THE EXCLUSION OR LIMITATION OF INCIDENTAL

OR CONSEQUENTIAL DAMAGES, SO THE ABOVE LIMITATION OR EXCLUSION MAY NOT APPLY TO YOU.

No variation or change in this limited warranty will be binding upon Wahoo Concrete Products unless made in writing and signed by an officer of Wahoo Concrete Products.

This limited warranty and the limitations set forth herein shall be governed by and construed in accordance with the laws of the state of Nebraska, exclusive of choice of law rules. TO THE EXTENT AND ONLY TO THE EXTENT THAT THE FOREGOING LIMITED WARRANTY AND LIMITATIONS OF LIABILITY ARE CONTRARY TO LAW, THE SAME SHALL NOT APPLY.

This limited warranty shall only be applicable and enforceable in the United States of America.



Quick Veneer™

Visit [quickvener.com](https://www.quickvener.com)
or call (402) 443-4999

@ 2026 Quick Veneer. All Rights Reserved.